

Rugged Metal VME Handles

For VME and VXI



FEATURES

- Patented, all metal handles in extruded aluminum
- Conform to IEEE 1101.1 specifications for VME and VXI applications
- Our aluminum handles completely eject the PCB from the backplane
- Handles have flat plane to attach identification label
- All metal construction offers significant improvement over plastic
- No risk of out-gassing or burning in extreme environments



Triple E - Ruggedized Eurocard Packaging

Single CAM (VM-N, VM-W)

Versions

- Unique, robust design for rugged COTS VME applications
- Drop-in replacement design for plastic versions
- Finger grips are extruded into the handles for a sure eject every time
- N Style is direct replacement for Schroff VME plastic handle
- W Style is direct replacement for APW plastic handle



Twin CAM (VM-T, LM-T)

Versions

- Patented, all metal handle with traditional VME look
- Applies even ejection pressure across panel, reducing stress on PCB - even with stacked boards or wide panels
- Come in two versions: VM and LM

VM-T in Smooth Aluminum



LM-T in Medium Black



Contact our Sales Department by phone at 1-888-444-1644 or by email at tripleesales@xtech-outside.com



WWW.TRIPLEEASE.COM | 1-888-444-1644

TECHNICAL SPECIFICATIONS

Kits include:

Handle and PCB Mounting Block (Sets contain 2)

3 Screws per Handle

Single: SS FHP M2.5 X 8, PHP M2.5 X 2, Combo Slot M2.5 X 10.5

Twin: 2 SS PHP M2.5 X 8, and 1 Combo Slot M2.5 X 10.5

Plus, per Handle:

Single Cam

Pivot Bushing

Press in Plastic Screw Sleeve

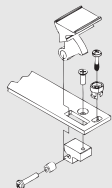

Twin Cam

Dowel Pin

Each Ejector is made of Extruded Aluminum and finished with a Robust Powder Coat

Single VM-N
Narrow Version

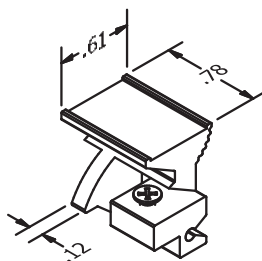

Single VM-W
Wide Version

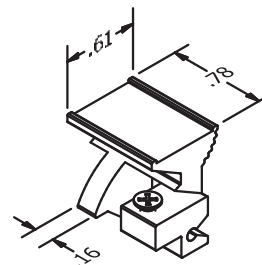

Twin LM-T
Version

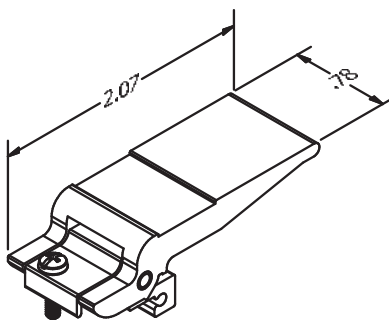

Twin VM-T
Version

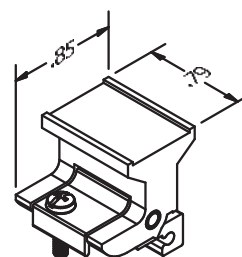

Single, Narrow Cam Handle Front Panel Cutouts

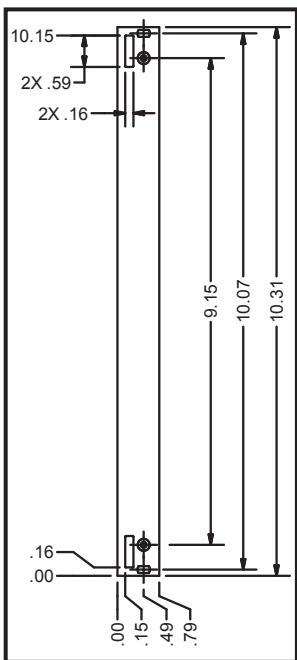

Single, Wide Cam Handle Front Panel Cutouts

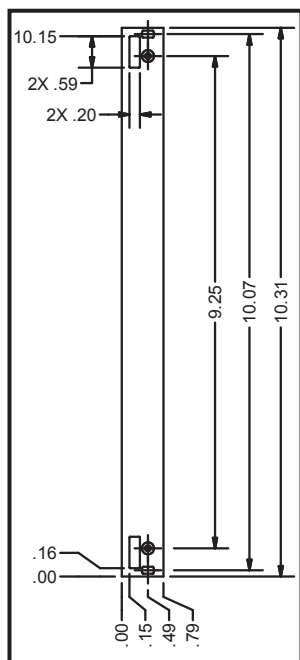

Twin Cam Handle Front Panel Cutouts

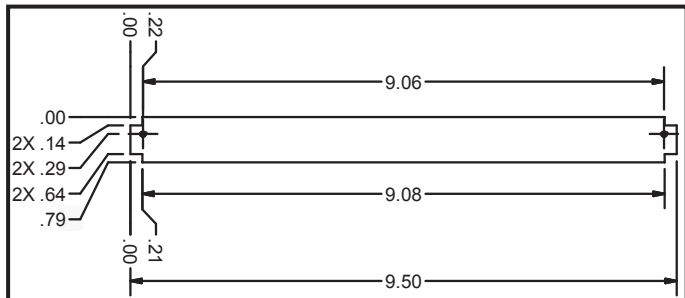

PN	Model	Description	Finish	Color	Order Qty
127259	EJL-VM-N-X4-X4-B2	Single, Standard, Lower	Smooth	Black	Multiples of 10
128211	EJS-VM-N-X4-X4-B2	Single Cam, Upper/Lower Set	Smooth	Black	Multiples of 10
130084	EJL-VM-W-X4-X4-B2	Single, Wide, Lower	Smooth	Black	Multiples of 10
130063	EJS-VM-W-X4-X4-B2	Single Cam, Upper/Lower Set	Smooth	Black	Multiples of 10
	EJU-LM-T-X4-X4-A1	Twin, Low Profile, Long, Upper	Smooth	Aluminum	Multiples of 10
	EJL-LM-T-X4-X4-A1	Twin, Low Profile, Long, Lower	Smooth	Aluminum	Multiples of 10
	EJU-LM-T-X4-X4-AX	Twin, Low Profile, Long, Upper	Fine	Aluminum	Multiples of 10
	EJL-LM-T-X4-X4-AX	Twin, Low Profile, Long, Lower	Fine	Aluminum	Multiples of 10
	EJU-LM-T-X4-X4-BX	Twin, Low Profile, Long, Upper	Medium	Black	Multiples of 10
	EJL-LM-T-X4-X4-BX	Twin, Low Profile, Long, Lower	Medium	Black	Multiples of 10
128307	EJU-VM-T-X4-X4-A1	Twin, Standard VME, Upper	Smooth	Aluminum	Multiples of 10
128306	EJL-VM-T-X4-X4-A1	Twin, Standard VME, Lower	Smooth	Aluminum	Multiples of 10
126422	EJU-VM-T-X4-X4-AX	Twin, Standard VME, Upper	Fine	Aluminum	Multiples of 10
126421	EJL-VM-T-X4-X4-AX	Twin, Standard VME, Lower	Fine	Aluminum	Multiples of 10
126692	EJU-VM-T-X4-X4-BX	Twin, Standard VME, Upper	Medium	Black	Multiples of 10
126693	EJL-VM-T-X4-X4-BX	Twin, Standard VME, Lower	Medium	Black	Multiples of 10
127761	SC-000237	Screw-Pan Combo Panel Mount	M2.5 X 10.5	SS	Kit of 100

Shop online at www.xtech-outside.com/store



tripleesales@xtech-outside.com
358 North Street, Randolph, MA 02368
www.tripleease.com
US Sales: 1-888-444-1644